

4-20mA Loop Calibrator Model 100

Table of Contents

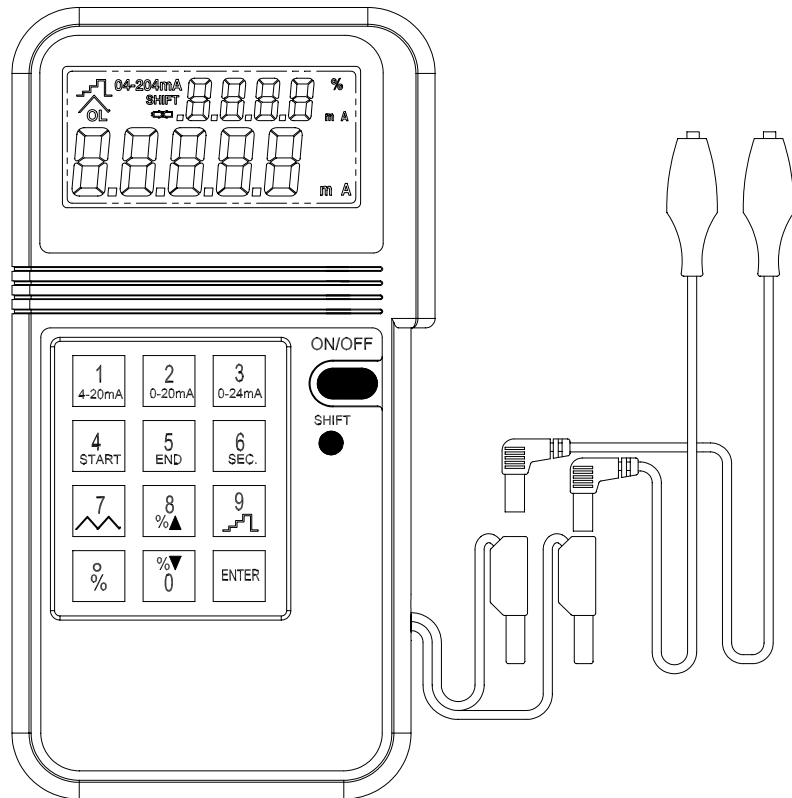

I. PANEL DESCRIPTION.....	1
II. OPERATING INSTRUCTION	7
1. MA OUTPUT	7
1A. GENERAL OPERATION 4 - 20MA	7
1B. SELECT 0 - 20MA OR 0 - 24MA	8
1C. ENTER A VALUE LESS THAN 1	9
2. % (PERCENTAGE) INPUT	10
3. EASY STEP UP AND DOWN	12
4. AUTO STEP FUNCTION:	14
5. AUTO RAMP FUNCTION	15
6. 0 TO 24 V OUTPUT	18
III. ELECTRICAL SPECIFICATION (23°C ± 5°C)	19
IV. USE THE AC ADAPTER.....	20
V. USE EXTERNAL BATTERY PACK	21
VI. BATTERY REPLACEMENT	22

Features:

1. 4-20mA (1K Ω load, 24V Loop Supply)
2. 0.025% Basic Accuracy
3. Easy Key-pad Operation
4. Auto Step and Auto Ramp Functions
5. 0-20mA, 0-24mA selectable
6. 0-100% input, step up and down.
7. Beeper warning when output is open
8. 0-24 V output

PROVA INSTRUMENTS INC.

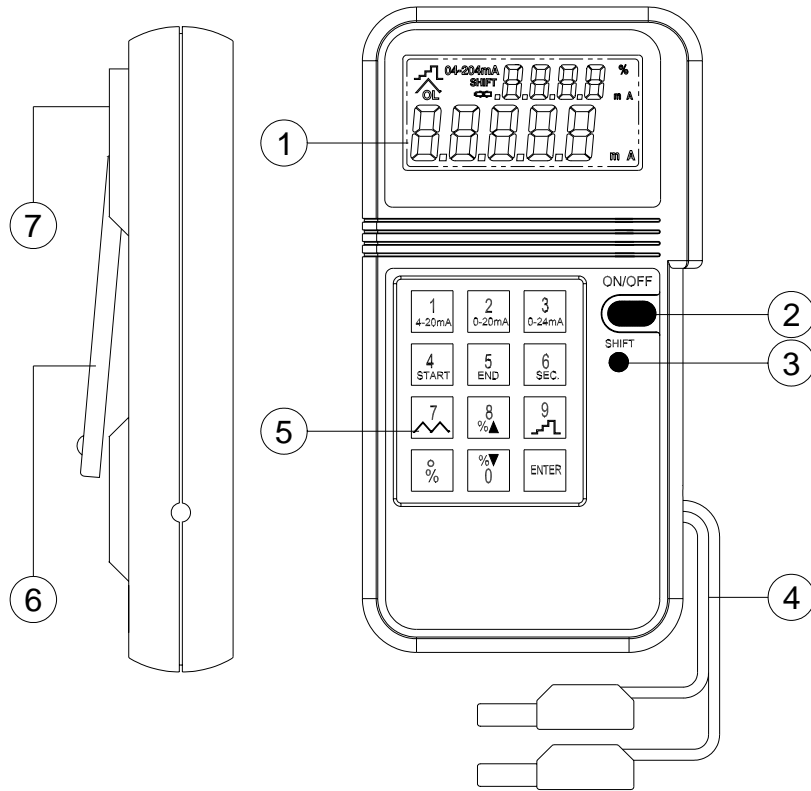

I. Panel Description



- 1. LCD DISPLAY
- 2. ON/OFF BUTTON
- 3. SHIFT BUTTON
- 4. OUTPUT LEADS

- 5. NUMERICAL & FUNCTION KEYPAD
- 6. STAND
- 7. AC ADAPTOR INPUT SOCKET



- 1.mA: Units
- 2.04-204mA : Range of mA
- 3.%: Percentage
- 4.  : Ramp
- 5.  : STEP
- 6.OL: Overload, output open
- 7.SHIFT: Select SHIFT functions
- 8.  : Battery low

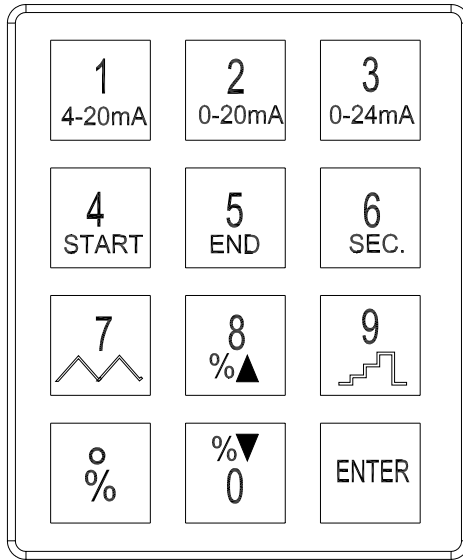

1.

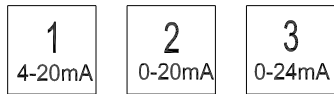

Press SHIF-I button, and then press one of these three buttons to select desired mA range

2.



Press SHIFT button, then press this button to enter the START value for auto ramp function

3.

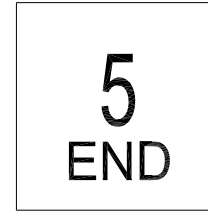

Press SHIFT button, then press this button to enter END value for auto ramp function

4.

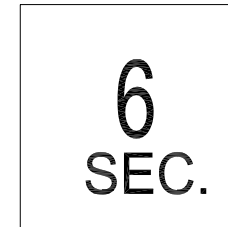

Press SHIFT button, then press this button to enter duration in SECONDS for auto ramp function.

5.

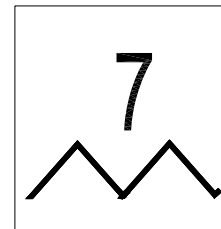

Press SHIFT button, then press this button to perform auto-ramp function. To stop the auto-ramp function, press this button again

6.

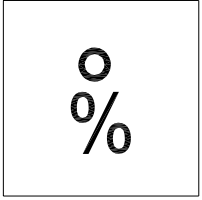

Press SHIFT button, then press this button first to enter percentage (0 –100)

7.

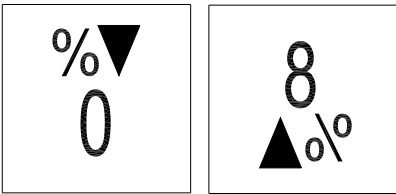

While the calibrator is in the SHIFT mode, and the percentage is entered, press these buttons to increment or decrement %.

8.

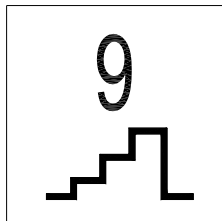

Press this button to start auto STEP function. To temporarily stop STEP function, press this button again.

9.

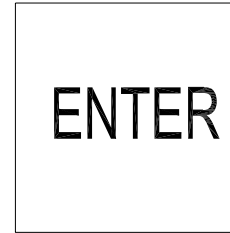

Always press this button to complete the entry of numbers.

II. Operating Instruction

1. mA Output

1a. General Operation 4 - 20mA

- 1 Turn the power on, and wait until the STBY symbol disappears (about 1 min.)
- 2 Plug the test leads into the output connectors of calibrator accordingly (Black to black, red to red). Attach alligator clip if necessary.
- 3 Press the keypad (including the decimal point) to enter the value of mA directly.
- 4 Using the test leads or alligator clips, touch or clip on the terminals to be calibrated.

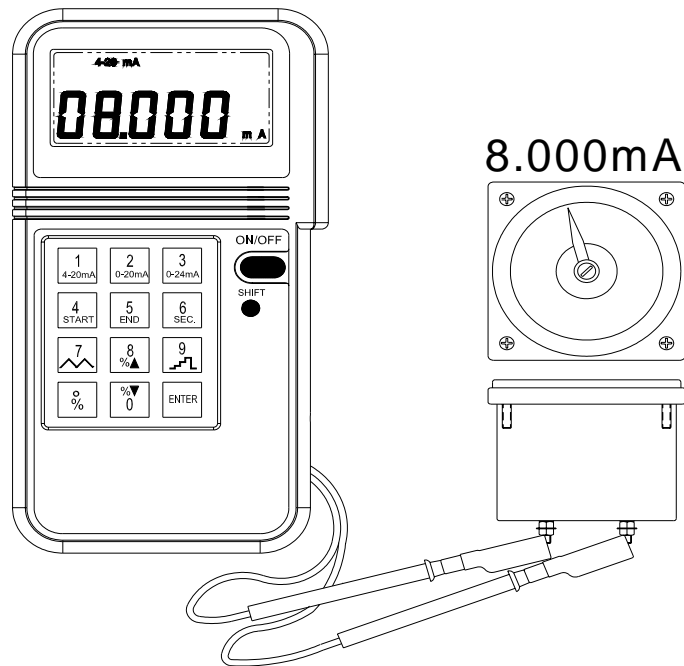

1b. Select 0 - 20mA or 0 - 24mA

The default setting for mA function is 4 - 20mA. But users can select 0 - 20mA or 0 - 24 mA by pressing the SHIFT button to enter the SHIFT mode. Then press the NUMBER 2 or NUMBER 3 button to select desired DC current range. After desired range is selected, press the shift button to exit the SHIFT mode. Corresponding current range symbol will be displayed in the LCD.

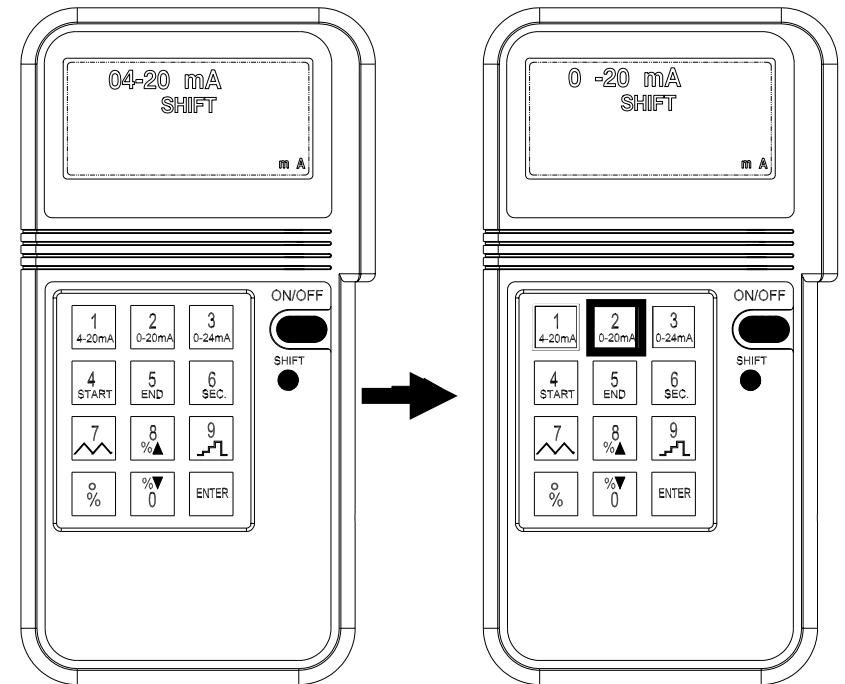

Note: Maximum 5 digits can be entered. If users enter less than 5 digits (1 to 4 digits), users must press ENTER button to indicate the end of entry. If users enter 5 or more digits, calibrator will automatically end the entry and output specified value current.

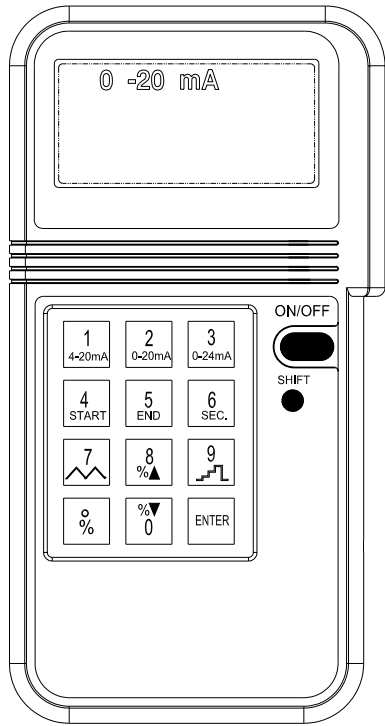

1c. Enter a value less than 1

In the mA functions, the standard way to enter a value less than 1 is to press leading before pressing the decimal point. Though the decimal point can be entered, the decimal point will not be shown in the LCD.

2. % (percentage) input

To enter percentage (%)

1. Users press the shift button first, then SHIFT symbol will be displayed in the LCD.
2. Press % button first, then press the number (no decimal number, the % resolution is 1%).
3. After percentage is entered, the percentage will be displayed in the upper LCD, and the corresponding value will be displayed in the lower LCD.
4. The corresponding value is calculated based upon the range selected.

4-20mA:	1% = 0.16mA (start at 4 mA)
0-20mA:	1% = 0.2mA
0-24mA:	1% = 0.24mA
5. To exit the percentage-input mode, press the SHIFT button again.
6. After the SHIFT button is pressed, the upper LCD will become blank, while the lower LCD retains its last value.

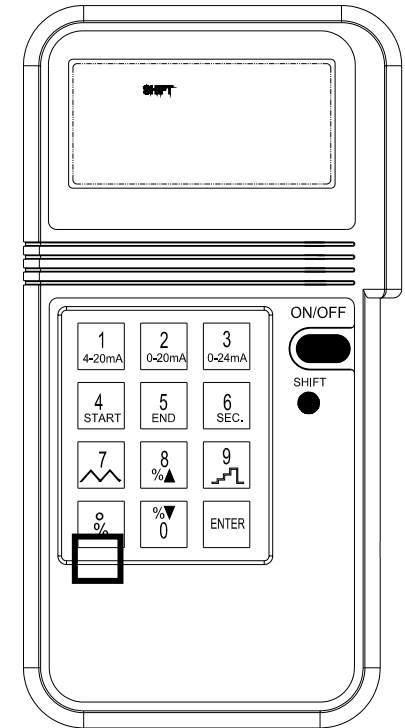
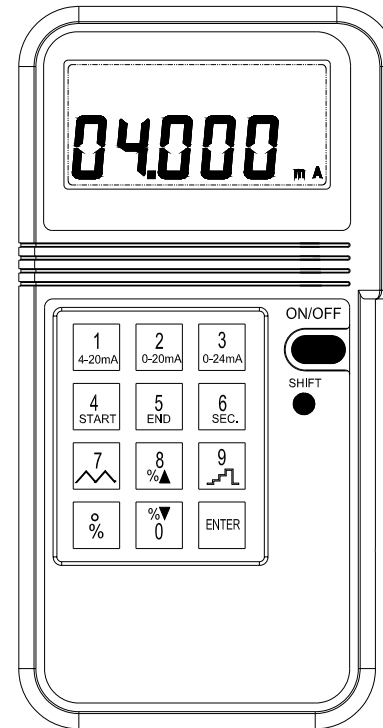

3. Easy Step Up and Down

While the percentage is entered and calibrator is still in the SHIFT mode, users can step up or down by the percentage entered. The maximum percentage is 100% while the minimum percentage is 0%. If the next step up or down exceeds the maximum or minimum percentage, the percentage will stay in the previous step.

Example 1: Step Up and Down(25%):

25% -> 50% -> 75% -> 100% -> 75% -> 50% -> 25% -> 0% -> 25%

Example 2: Step Up and Down(30%):

30% -> 60% -> 90% -> 60% -> 30% -> 0% -> 30%

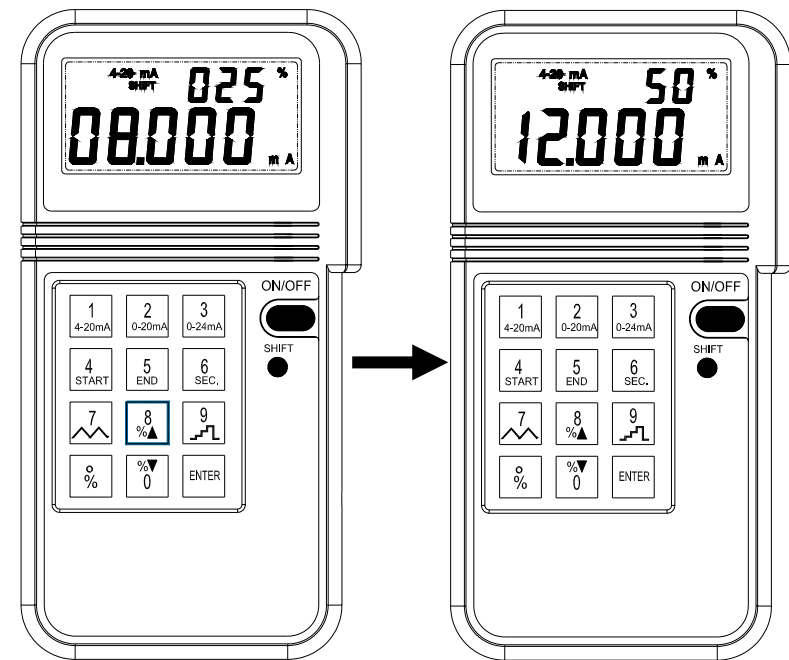
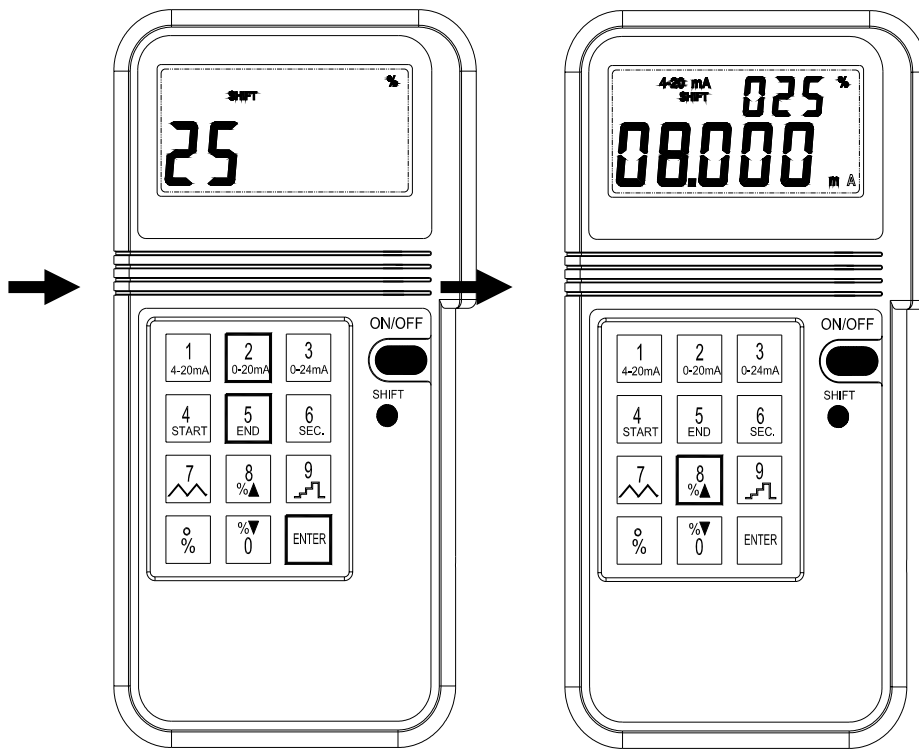

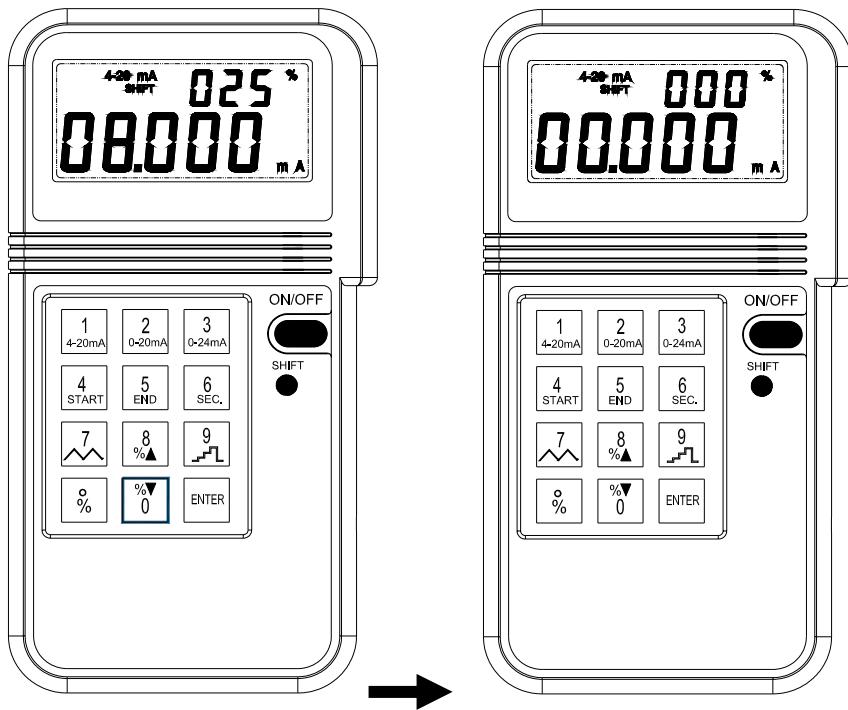

4. Auto Step Function:

4a. Start Auto Step Function

The default percentage is 25%, and the default duration for step is 4 seconds.

1. To start auto step function, press the SHIFT key to enter SHIFT mode.
2. Press the NUMBER 9 key to start. Calibrator outputs 0% of the range for 4 seconds. Then increment the output to 25% and keep the output at that value for another 4 seconds, then 75%(4 seconds), 100%(4 seconds), 75%(4 seconds), 25%(4 seconds), 0%(4 seconds), 25%(4 seconds) ...
3. To temporarily stop the step function, press the NUMBER 9 key again.

4b. Change the Step Size (%) and Duration

Step Size (%)

1. Press the SHIFT key to enter SHIFT mode.
2. Press the DOT key, enter the value of percentage (%), then press the ENTER key.

Duration

1. Press the SHIFT key to enter SHIFT mode.
2. Press the NUMBER 6 key, enter the value in seconds for the DURATION, then press the ENTER key.

5. Auto Ramp Function

5a. Start Ramp Function

The default setup for the auto ramp function is as follows:

RANGE	START	END	DURATION
4-20mA	4mA	20mA	4seconds
0-20mA	0mA	20mA	4seconds
0-24mA	0mA	24mA	4seconds

To start the ramp function:

1. Press the SHIFT button to enter the SHIFT mode.
2. Press the NUMBER 7 key to start
3. Calibrator outputs current (mA) from START value to END value in the DURATION specified by users then outputs from END value to START value in the DURATION repeatedly.
4. To temporarily stop the ramp function, press the NUMBER 7 key, and the output will stay at the value when the NUMBER 7 key is pressed. To restart again, press the NUMBER 7 button again.
5. To return to the regular output mode, press the SHIFT button again when ramp function is stopped.

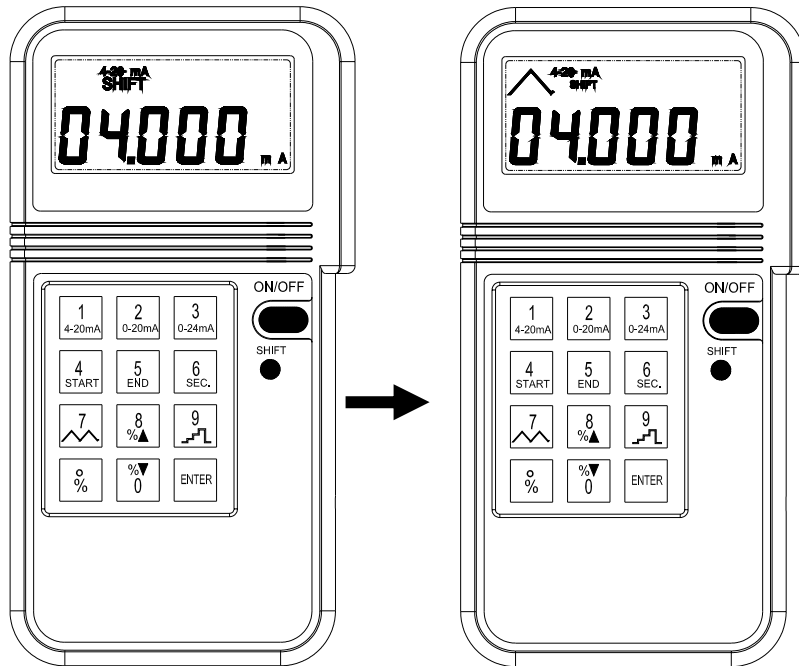

15

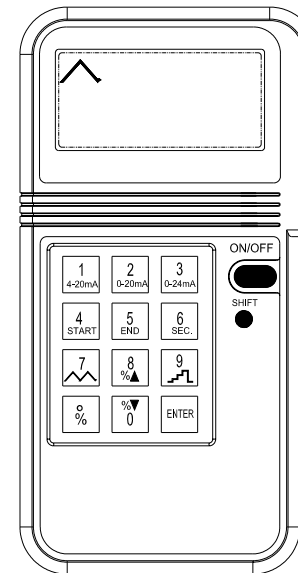
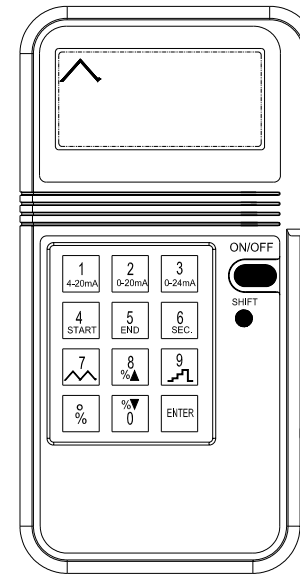

16

5b. How to change the START, END and DURATION of the RAMP function

START:

1. Press the SHIFT button to enter the SHIFT mode.
2. Press the NUMBER 4 key, then LCD will display STA in the upper LCD.
3. Enter the desired start value, then press ENTER key.

END:

1. Press the SHIFT button to enter the SHIFT mode.
2. Press the NUMBER 5 key, then LCD will display END in the upper LCD.
3. Enter the desired end value, then press ENTER key.

DURATION:

1. Press the SHIFT button to enter the SHIFT mode.
2. Press the NUMBER 6 key, then LCD will display SEC in the upper LCD.
3. Enter the desired duration in seconds, then press ENTER key. The range for duration is from 1 to 2000 seconds

NOTE: Users should set an appropriate value for the duration of ramp function. For a full range ramp, users should enter at least 4 seconds for the duration.

6. 0 to 24 V Output

To set unit in voltage output mode, hold the "SHIFT" button, then press the ON/OFF button to turn the power on. When the unit is in Voltage output mode, the LCD will show symbol of V instead of mA. The mA and the dash symbols in the range indication will disappear. For example, "0 20" means 0 to 20V. "4 20" means 4 to 20V. "0 24" means 0 to 24V. The default range is 0 to 24V.

The rest of the operation is exactly the same as mA output.

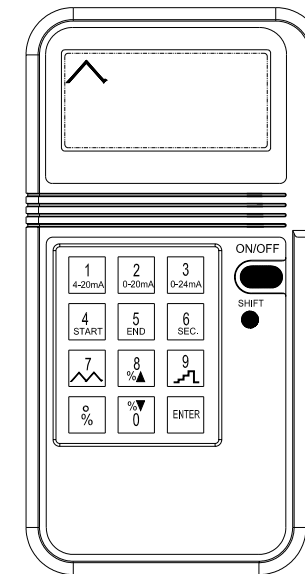

III. Electrical Specification (23°C ± 5°C)

mA DC Current (1K Max. Load, 24V Loop Supply)

Range	Resolution	Accuracy
0 – 4mA	1µA	± 0.025% ± 10µA
4 – 20mA	1µA	± 0.025% ± 5µA
20 – 24mA	1µA	± 0.025% ± 5µA

Beeper warning when output is open and specified output > 1mA

V DC Voltage

Range	Resolution	Accuracy
0 – 4V	1mV	± 0.05% ± 10mV
4 – 20V	1mV	± 0.05% ± 5 mV
20 – 24V	1mV	± 0.05% ± 5 mV

Beeper warning when output is short and specified output > 100mV

General Specification:

Battery Type: 9V Alkaline Battery
 Power Consumption: 25 mA at 100 load
 Display: 4+ 5 Digits
 Operating Temperature: 0 to 50°C (32 to 122 °F)
 Operating Humidity: Less than 85% relative
 Storage Temperature: -20 to 60° C (-4 to 140 °F)
 Storage Humidity: Less than 85% relative
 Dimension: 88 x 168 x 26 mm
 (3.46" x 6.61" x 1.03")
 Weight: 330 g / 11.63 oz
 Accessories: Carrying case x 1
 Users Manual x 1
 External Battery Pack
 6 1.5V AA Batteries
 Alligator clip x 1

IV. Use the AC adapter

If long term usage of the calibrator is required, AC adapter can be used. The 12V AC terminal is located in the back of the calibrator. The voltage should be regulated between 9 to 15V.

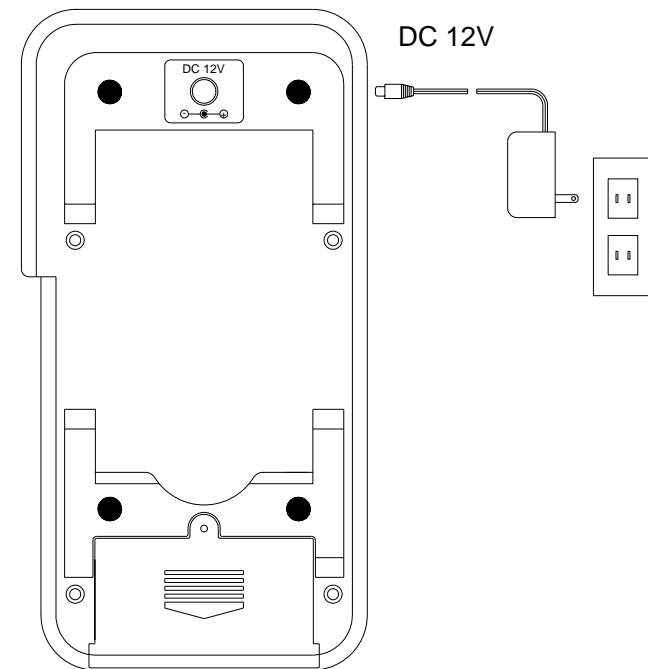

V. Use External Battery Pack

An external battery pack is included for a longer period usage. The external battery pack needs to be packed with 6 pieces of 1.5 volts AA batteries. To use the external battery pack, plug into the AC terminals located in the back of the calibrator.

BATTERY HOLDER

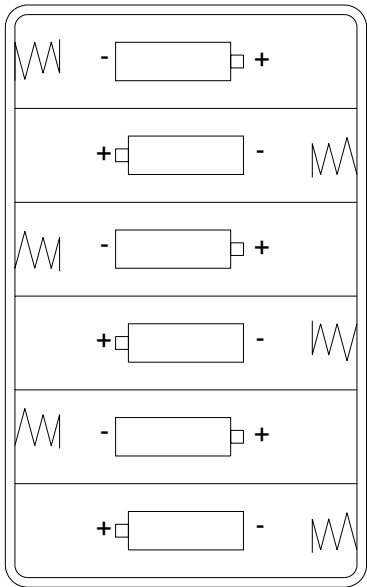

BATTERIES 6x1.5V AA

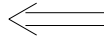
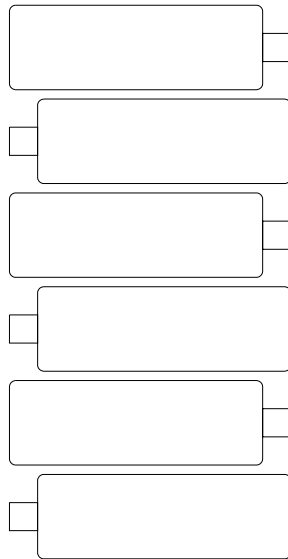

VI. Battery Replacement

When the low battery symbol is displayed on LCD, follow the following procedures to replace the battery.

- 1 Turn off the calibrator by pushing the On/Off button.
- 2 Remove the screw of the battery compartment cover and remove the battery compartment cover.
- 3 Replace the old 9V battery with a new alkaline 9V battery.
- 4 Replace the battery compartment cover and fasten the screw.

